

Battery Weighing Indicator

BW Series

OWNER'S MANUAL

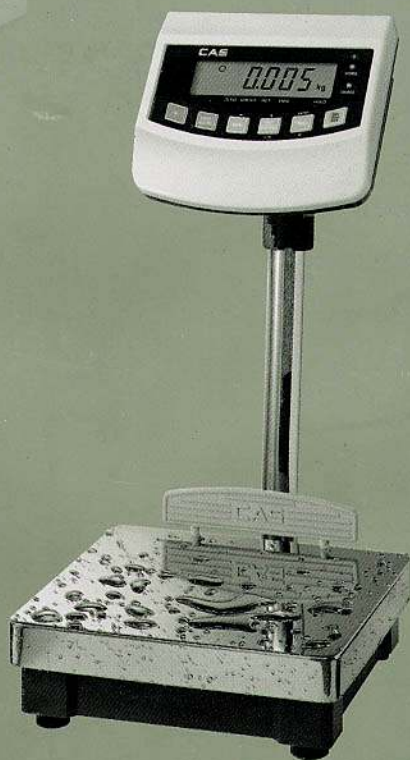

CONTENTS

INTRODUCTION	4
CAUTIONS	4
FEATURES & MAIN FUNCTIONS	4
SPECIFICATIONS	5
PART NAME AND FUNCTION	5
SYSTEM MODE	7
GENERAL FUNCTION & DESCRIPTIO	13
CONVERSION MODE	15
USING & KEEPING	18
BATTERY	18
HOW TO INSTALL THE BW-SERIES	20
ERROR MESSAGE DESCRIPTION AND MANAGEMENT	21

INTRODUCTION

We greatly appreciate for you to purchase BW-SERIES of CAS. This goods has the excellent performance and splendid properties through strict test under severe quality management.

It is recommended to read this manual in full before using BW-SERIES for good function application.

CAUTIONS!

- Do not press the key strongly.
- Do not use the inflammables at cleaning.
- Do not install in the place with sudden temperature change.
- Do not install in the place with high voltage and terrible electrical noises.
- Do not use in the place exposed directly to the sun and including much dust.
- Do not use in the place with excessive electrical noises and shaking.
- Charge a battery in full to use after negligence for a long time.
- Install the platform on a flat place.

FEATURES

- Simple outdoor using in use of battery
- Using general (Mn, Alkaline) battery or rechargeable battery
- Easy operation and various functions
- Waterproof(IP65)
- High precise resolution
- Liquid crystal display of 5 place weight (LCD)
- Using long-time battery
- Various options (RS232, BACK LIGHT)

Main functions

- Weight averaging function(Hold function)
- COUNT function (Unit weight setting, unit weight setting by sample)
- Low/High weight comparing
- Auto power OFF

SPECIFICATION

ITEM \ MODEL		BW-SERIES				
		BW-6	BW-15	BW-30	BW-60	BW-150
MAX. CAPACITY		6kg	15kg	30kg	60kg	150kg
MINI. DIVISION		2g	5g	10g	20g	50g
PLATFORM SIZE		280(W) × 280(D) × 80(H)			405(W) × 525(D) × 105(H)	
FUNCTION	STANDARD	ON/OFF, ZERO, TARE, HOLD, COUNT, HIGH/LOW comparing				
	OPTION	RS-232C, BACK LIGHT				
LOADCELL PERMISSION VOLTAGE		5V DC				
TEMPERRATURE RANGE		-10 °C ~ +40 °C				
MAX. TARE RANGE		Max. Capacity				
REZERO RANGE		± 2% of Max. Capacity				
INITIAL ZERO RANGE		± 10% of Max. Capacity				
WEIGHT DISPLAY TYPE		5 place LCD(Char. size 23.5 mm)				
CHARACTER DISPLAY		1. Stable (○) 2. High, Normal, Low (HI, OK, LO) 3. Battery discharge (BAT) 4. quantity unit (PCS) 5. Weight unit (kg, lb)				
POWER		1. DC 7.2V (6EA SIZE "C") 2200 mAh Recharging Battery 2. DC 9V (6EA size "C") Mn. Alkaline battery 3. DC 12V 850mA AC Adapter				
CONSUMPTION		Approx. 0.15W				



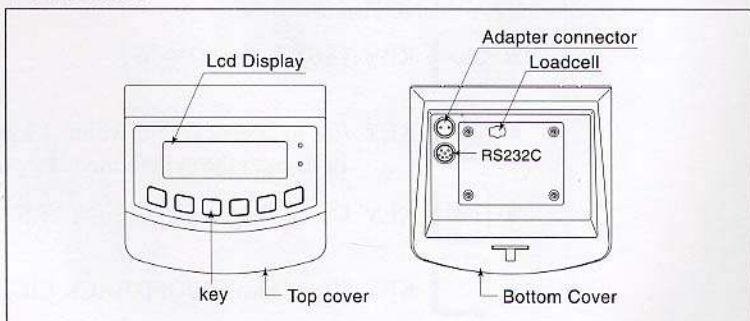

Part name and function

Part name

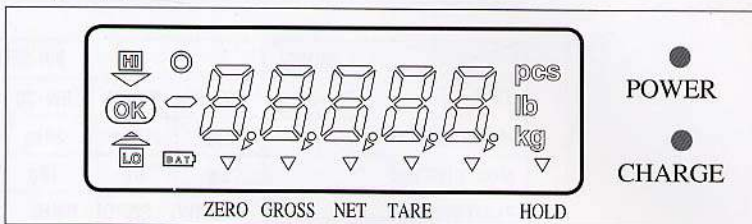





Display part





- ZERO lamp : ON when the current weight is "0".
- TARE lamp : ON when the TARE weight is saved.
- GROSS weight lamp : ON at displaying the total weight.
- NET weight lamp : ON at displaying the pure weight.
- Hold lamp : ON at weighing the moving object.
- BAT lamp : In case of rechargeable battery, display the battery recharging time.
In case of general Mn/Alkaline battery, display the battery replacing time.
- CHARGE lamp : OFF when the charging is completed at charging in use of adapter.
- POWER lamp : ON at connecting DC 12V adapter.
-  lamp : ON when the current weight exceeds normal weight.
-  lamp : ON when the current weight is normal.
-  lamp : ON when the current weight is 80-90% of normal weight
-  lamp : ON when the current weight is 50-80% of normal weight
-  lamp : ON when the current weight is below 50% of normal weight.

KEY PART



KEY FUNCTIONS

-  KEY : Use to power ON/OFF.
-  KEY : Use in case of rezero(within 2% of max. capacity) or to enter the system mode by pressing for 2 sec.
-  KEY : Use at weighing in use of TARE.
-  KEY : Use to turn ON/OFF BACK LIGHT.(Option)

Key functions in Simple weighing mode & in Low/High comparing mode.

-  KEY: Use to display NET weight or GROSS weight.
-  KEY: Use to weigh the moving object.
(Manual, Automatic)

Key functions in COUNT mode

-  KEY: Use to display the unit weight.(for approx. 5 sec.)
-  KEY: Use to display the current weight.
(for approx. 5 sec.)

SYSTEM MODE

- Simple weighing mode : Display the weight after weighing
- High/Low comparing mode : Determine that the weight is high, normal or low value and perform the display.
- Count mode : Display the quantity by setting the unit or sample weight
- Quantity comparing mode : Perform the display after discrimination by setting High/Low quantity.

MODE CONVERSION

- Press  key for 2 sec. to display the following message.







545

- Execute depending on the below mode conversion and setting method.









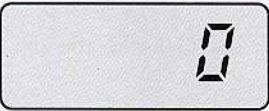

DIGIT INPUT METHOD

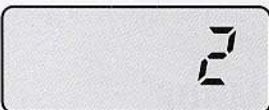
Input the digit in use of the below keys.





-  KEY: Use to set the inputted value to '0'.
-  KEY: Use to increase the first place of value by one.

-  KEY : Use to move the inputted value to the left by one place.
-  KEY: Use to input a decimal point.
-  KEY: Use to complete the input

Ex) For 20.5 input

	DISPLAY	KEY	DESCRIPTION
Step 1			Press once (Set to "0")
Step 2			Press twice (Input 2 as the first place value)
Step 3			Press once (Move to the left by one place)
Step 4			Press once (Decimal point input)
Step 5			Press five times (Input 5 as the first place value)
Step 6			Input completion

SIMPLE WEIGHING MODE CONVERSION

	DISPLAY	KEY	PLATFORM	DESCRIPTION
Step 1				Press once
Step 2			Empty	Press once. Generally operated

High/Low comparing mode conversion

■ In case of no resetting the High/Low value

	DISPLAY	KEY	PLATFORM	DESCRIPTION
Step 1				Press twice
Step 2			Empty	Press once Generally operated

■ In case of resetting the High/Low value

	DISPLAY	KEY	PLATFORM	DESCRIPTION
Step 1				Press twice
Step 2				Press once Generally operated
Step 3				Refer to 'digit input' in page 8.
Step 4				High value input
Step 5				Refer to 'digit input' in page 8.
Step 6			Empty	Generally operated

COUNT MODE CONVERSION

- In case of no setting the unit/sample weight

	DISPLAY	KEY	PLATFORM	DESCRIPTION
Step 1				Press three times
Step 2			Empty	Press once Generally operated

- In case of setting the unit weight
(Min. range of unit weight : Min. Division)

	DISPLAY	KEY	PLATFORM	DESCRIPTION
Step 1				Press three times
Step 2				Press once
Step 3				Display the set weight
Step 4		Set 'digit input' in page 8.		Input the unit weight
Step 5				Press 'Mode' key to round and display unit weight. Generally operated.

Step 5. Ex) Min. division is 0.1

Input the unit weight as 0.532 and round off the second place of decimal to 0.5.

- In case of setting the unit weight by sample
(Samples : 10-200, 10 unit)

	DISPLAY	KEY	PLATFORM	DESCRIPTION
Step 1				Press three times
Step 2				Press once
Step 3				Press once
Step 4				Press once
Step 5			Empty	Press five times. Simple count input. (50pcs)
Step 6			Empty	Press once
Step 7			Sample	Press once with platform loaded.
Step 8				Unit weight display. Press once.
Step 9				
Step10			Empty	Generally operated

* Note : For setting the unit weight by sample count, the min. unit weight shall be more than min. division.

COUNT COMPARING MODE CONVERSION

- In case of no setting the High/Low quantity

	DISPLAY	KEY	PLATFORM	DESCRIPTION
Step 1				Press four times
Step 2				Press once. Generally operated.

- In case of setting the High/Low quantity

	DISPLAY	KEY	PLATFORM	DESCRIPTION
Step 1				Press four times
Step 2				Press once. Low value setting.
Step 3		Set 'digit input' in page 8.		Low value input.
Step 4				Press once. High value setting.
Step 5		Set 'digit input' in page 8.		Press once. High value input.
Step 6			Empty	Press once. Generally operated.

GENERAL FUNCTION & DESCRIPTION

REZERO FUNCTION(Use in case of rezero)

- Rezero band range : Within 2% of Maximum capacity

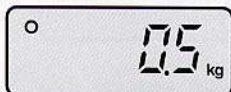

Zero point is changed



Press 'Zero' key.
Zero lamp is ON.

TARE FUNCTION(Use at weighing in use of TARE)

- Maximum TARE range : Maximum capacity

* Note : The weight including TARE weight can't exceed the maximum capacity.



Put the TARE on platform.
(TARE weight: 10kg)



Press 'TARE' key.
(The TARE weight is saved)



Put the object on platform.
(object weight: 20kg)

- In case to want know the Gross weight



Press 'NET/GROSS' key.
(object + TARE weight display)

- In case to want know the Net weight



Press 'NET/GROSS weight' key.
(object weight display)
Remove the TARE and object from platform to display
the saved TARE weight.

- In case to want know the Tare weight



Remove the TARE and object from
loadcell and press 'TARE' key.

HOLD function (Use at weighing the moving object) —

- Auto hold function (Hold function operated whenever weighing)

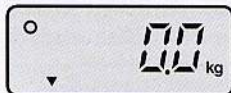

Empty the platform.

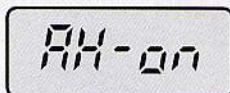

Press 'Hold' key.
'Auto hold' message is displayed for 1 sec.

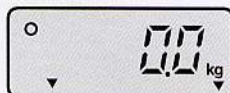

Hold lamp is ON.



When the weight change is stable after putting the object (20kg) on platform, 'Hold' message is displayed.

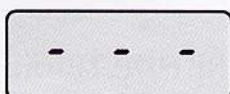

The weight is averaged for approx. 3-5 sec



The hold weight is displayed

- To release the hold weight Empty the platform or press 'Hold' key and perform the normal operation.

Auto hold function release

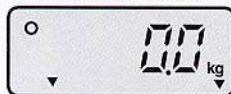

Empty the platform.



Press 'Hold' key'.
'Auto hold release' message is shown for 1 sec. and then normally operated.
'Hold' lamp is OFF.

Manual hold function (Executed at pressing 'Hold' key)



Put the object (10kg) on platform.

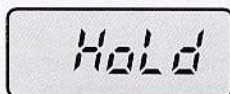

Press 'Hold' key.
'Hold' message is displayed for 1 sec.



The weight is averaged for 3-5 sec.





The hold weight is displayed.
Empty the platform or press 'Hold' key to release the hold weight and perform the normal operation.
'Hold' lamp is OFF.

CONVERSION MODE

Enter method

- If you press the * key for three seconds to normal operation state, after display "SET" message for one second and then enter F-1 menu.

Key using

-  : Increase the set point.
-  : Move to the next menu.
-  : Return to the normal operation at completion of setting.

Conversion menu (F01 - F02)

F-1: Auto power OFF setting

F-2: RS-232C communication setting

- F-1: Auto power OFF setting

Auto power OFF function is used to spare the battery by means of power off when this scale is not used.

Set point	Meaning
F-1 0	Auto power OFF is not used.
F-1 1	Automatically power off when the weight is not changed or no key is used for 5 min.

- F-2: RS-232C communication setting (option)

Set point	Meaning
F-2 0	No transmit.
F-2 1	Transmit at both stable and unstable weight.
F-2 2	Transmit at stable weight.
F-3 3	Transmit at data request. (Data request signal "D")

RS-232C communication (option)

Port connection method

Connect the computer serial port with RS-232C port in the back panel of indicator as follows to communicate with computer.

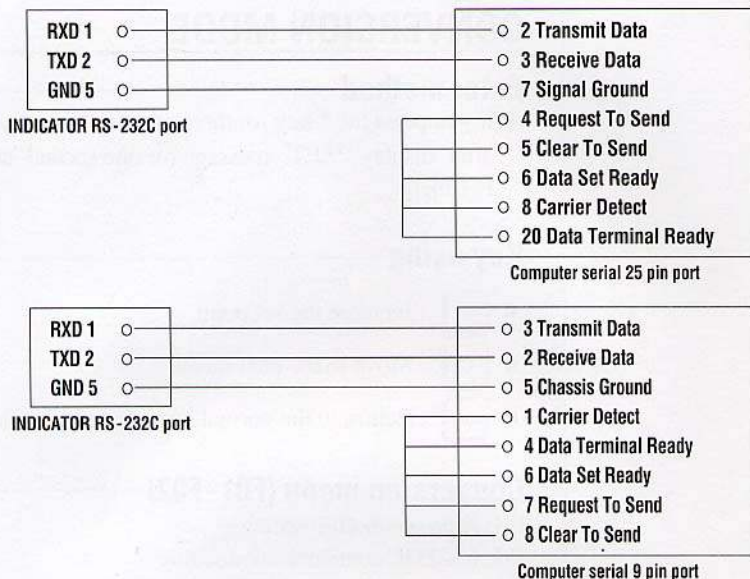

RS-232C Output data format

- Baudrate : 9600bps
- Data bit: 8, Stop bit: 1, Parity bit: None
- Code: ASCII

Transmit data format

Total 22 bytes

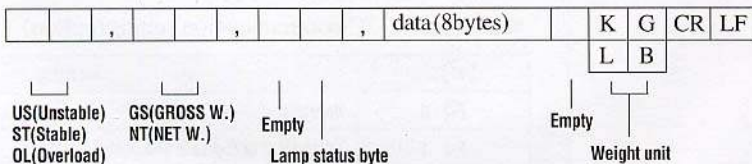

- Lamp status byte: Display the current state(ON/OFF) of indicator lamp.

bit7	bit6	bit5	bit4	bit3	bit2	bit1	bit0
1	Stable	High	Low	Hold	GROSS W.	TARE	ZERO

- Data(8bytes) : Weight data including a decimal point and "-".
That is, for -13.5kg, : Transmit ASCII code 8 bytes corresponding to "-", ".", "5", "k", "g", "1", "3", ".", "5"

■ Data request mode

If F-2 is set to 3, the indicator outputs the specified data when ASCII code corresponding to "D" is sent to it.

*** Simple transmit/receive program(Language: BASIC)

```
10 OPEN "COM1: 9600, N, 8, 1" AS #1
20 IF LOC(1) = 0 THEN 60
30 A$ = INPUT$(1, 1)
40 PRINT A$; " ";
50 GOTO 20
60 B$ = INKEY$: IF B$ = " " THEN 20
70 PRINT B$; " ";
80 PRINT #1, B$
90 GOTO 20
```

*** Simple transmit/receive program(C-Language)

```
#include <bios.h>
#include <conio.h>

#define COM1 0
#define DATA_READY 0x100
#define TRUE 1
#define FALSE 0

#define SETTING ( 0x00 | 0xE0 | 0x00 | 0x03 )

int main(void)
{
    int in, out, status, DONE = FALSE;
    bioscom(0, SETTING, COM1);
    printf("... BIOSCOM [ESC] to exit ... \n");
    while(!DONE)
    {
        status = bioscom(3, 0, COM1);
        if (status & DATA_READY)
            if (( out = bioscom(2, 0, COM1) & 0x7F) != 0)
                putchar(out);
            if ( kbhit() )
            {
                if ((in =getch()) == '\x1B')
                    DONE = TRUE;
                bioscom(1, in, COM1);
            }
    }
    return 0;
}
```

USING

- Replace the general(Mn, Alkaline)battery or charge the rechargeable battery in full at using after long-time storage.
- Open the top cover and check that the main power switch in the left bottom is ON as follows.
- Power on by pressing ON/OFF key in the front panel.

Power switch and connector position

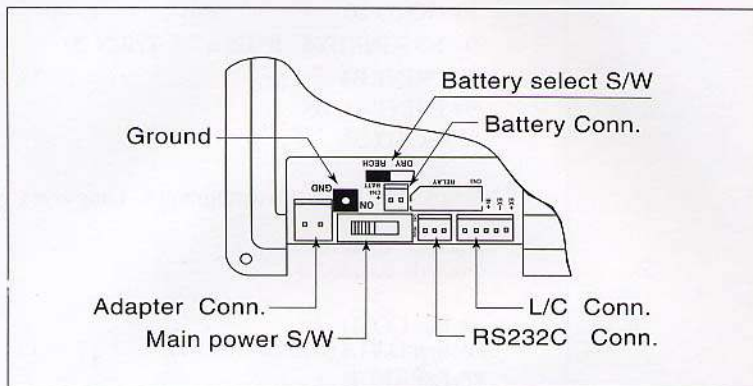

KEEPING

- Power off by pressing ON/OFF key.
- Open the top cover and power off for a long-time storage.

BATTERY

Battery replacement or charging time

- Power is off in a specific time after 'BAT' signal flickers in the left bottom of display part on using
- Replace the general battery or charge the rechargeable battery.

General (Mn, Alkaline) battery using and replacing

- Open the top cover and make as follows in the left bottom of cover at using the general (Mn, Alkaline) battery.
- Insert the battery into battery case after checking the battery polarity.

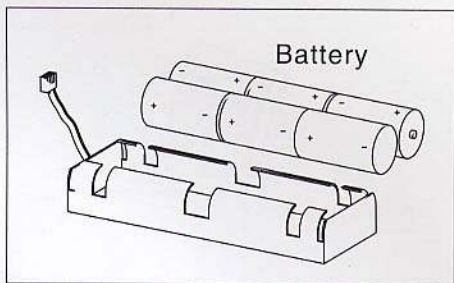
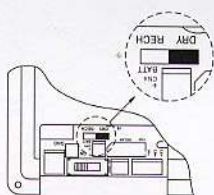

Rechargeable battery using and recharging

- Open the top cover and make as follows in the left bottom of cover at using the rechargeable battery.
- Open the jack protecting cap in the back panel and connect the adapter as follows.
- When the adapter is connected with indicator, RED(Power) lamp is ON.
- When the battery is charging, RED lamp is ON at charge lamp part.
- When the charging is completed, GREEN lamp is ON at charge lamp part.
- It takes approximately 4-5 hours to charge in full.

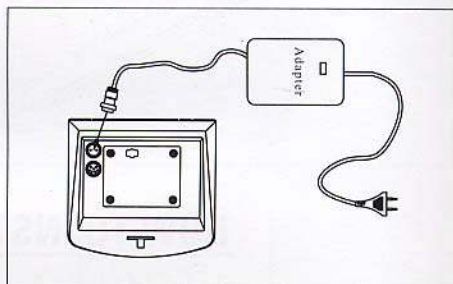

Battery using period

Conditions	Using period
BACK LIGHT(E.L) is not used.	Recharging battery : Approx. 100 hours Mn battery : Approx. 150 hours Alkali battery : Approx. 300 hours
BACK LIGHT(E.L) is always used	Recharging battery : Approx. 30 hours Mn battery : Approx. 45 hours Alkali battery : Approx. 90 hours

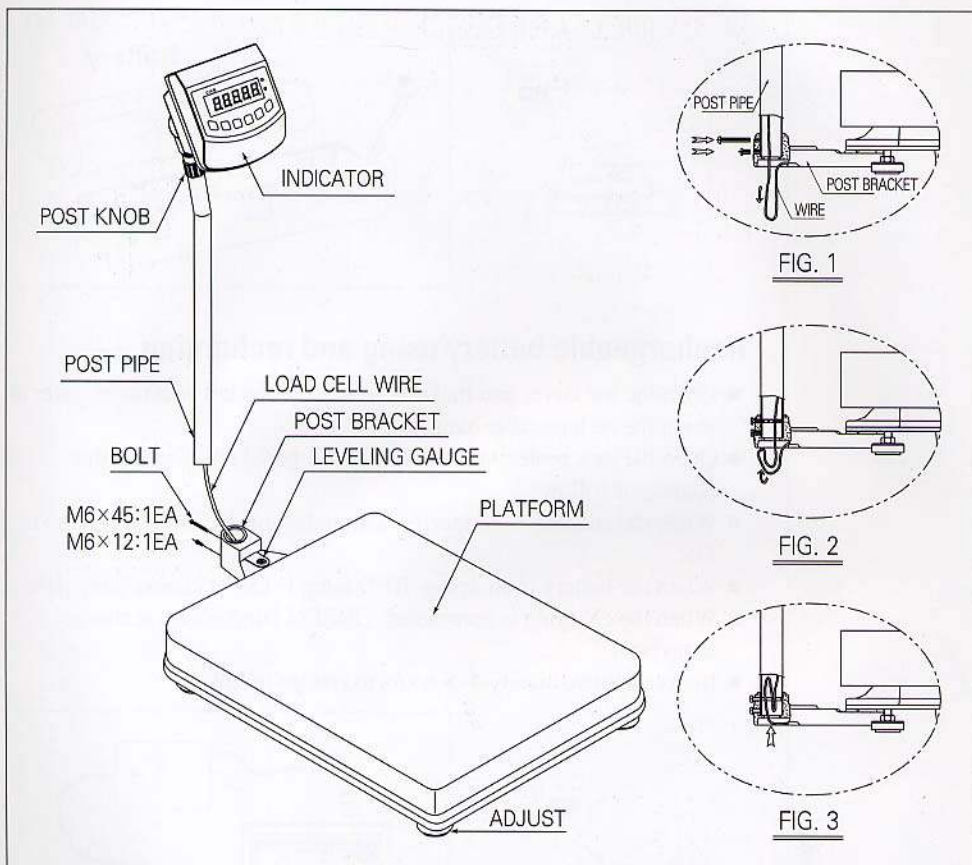

HOW TO INSTALL THE BW SERIES

1. Open the box with care because indicator is connected to the scale with load cell wire.
2. Turn the post knob so as to fix indicator.
3. Pull down the wire out of post pipe and insert the post pipe to the post bracket. (Refer to fig. 1)
4. Fasten the post pipe with two bolts. (Refer to fig. 1)
A long bolt should be connected to the upper side.
5. Insert the wire to the post pipe. (Refer to fig. 2, 3)
6. If the scale is not properly level, please adjust 4 leg (adjusting bolt) at the bottom of the scale so as to center the bubble of the leveling gauge.

* Note : Place the scale on a flat and stable surface.
Inside the indicated circle.

ERROR MESSAGE DESCRIPTION AND MANAGEMENT

Errors in weighing mode

Err 01

- Cause
The indicator can't be initialized due to platform shaking.
- Management
Put the platform on a flat place without shaking and power on.

Err 02

- Cause
The loadcell is connected wrongly or A/D conversion part has a fault.
- Management
Check that the loadcell is well connected with main unit.

Err 03

- Cause
The calibration isn't executed or the data of internal memory is lost due to a electrical shock.
- Management
Perform the required specification again in setting mode.

Err 06

- Cause
The printer isn't properly connected.
- Management
Check that the printer connector has no fault.
If the message is displayed in spite of no fault in printer and printer connector, call to A/S part of CAS CO., LTD.

Err 09

- Cause
The current weight exceeds zero range.

Err 10

- Cause
The specified TARE weight exceeds the maximum capacity.
- Management
Set the TARE weight lower than max. capacity.
Or set the maximum capacity higher than the desired TARE weight in calibration menu. and perform the calibration again.

Err 13

- Cause

The initial zero range exceeds above 10% of maximum capacity.

- Management

Check the loadcell state.

Over

- Cause

Too heavy object is put on platform so that it may exceed the maximum capacity.

- Management

Never put the weight exceeding the maximum capacity

If the loadcell is damaged, replace the loadcell.

Errors in count mode

Err 61

- Cause

The count unit weight and sample weight are set too high.

- Management

Set the count unit weight low or the sample quantity high.

Err 62

- Cause

The count unit weight and sample weight are set too low.

- Management

Set the count unit weight high or the count sample quantity low.

9007-BW0-0033-2

99.6