



**RETAIL WEIGHING SOLUTION™**

---

Price computing scale  
**OWNER'S MANUAL**

# **PR-II**

**SERIES**

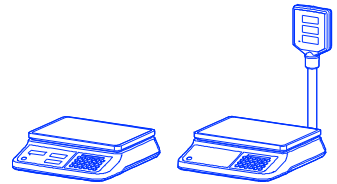

---

**CAS**

## CONTENTS

PRECAUTIONS	3
PREFACE, OVERALL VIEW	5
DISPLAY & KEY BOARD	6
COLUMN INSTALLATION	8
OPERATION	9
Chapter 1. Basic Operation	9
Chapter 2. PLU Saving & Calling-up	12
Chapter 3. User' s Set-up Mode	13
Chapter 4. Sales transaction	13
Chapter 5. Payment	16
Chapter 6. Interface in Detail	18
BATTERY MAINTENANCE	21
ERROR MESSAGE	21
SPECIFICATIONS	22

## PRECAUTIONS



### Warning

Precautions when installing the scale. To ensure that you get the most from your scale, please follow these instruction.



**Do not disassemble the scale.**

When any damage or defect occurs, contact your CAS authorized dealer immediately for proper repair.



**Do not overload beyond the maximum weight limit.**



**Scale must be grounded to minimize electricity static.**

This will minimize defect or electric shock.



**Do not pull the plug by its cord when unplugging.**

Damaged cord could cause electric shock or fire.



**To prevent from fire occurring, Do not place or use the scale near flammable or corrosive gas.**

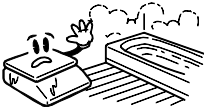

**To reduce electric shock or Incorrect reading, Do not spill water on the scale or place it in humid condition.**



**Avoid placing the scale near heater or in direct sunlight.**

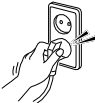

**Insert plug firmly to wall outlet to prevent electric shock.**



**Use proper Adapter.**

Incorrect adapter could damage the scale.

## PRECAUTIONS



### Attention

Make sure to plug your scal into the proper power outlet.

For maximum performance, plug into a power outlet 30 minutes before the usage for warm up.



For consistent and accurate reading, maintain periodical check by your CAS authorized dealer.



Avoid sudden shock to the scale.



Grab on the bottom of the scale when moving.



Keep the scale away from other electromagnetic generating devices.

This may interfere with accurate reading.



Place the scale on firm and temperature consistent environment.



By adjusting 4 corners of the scale, set the scale even using the built in scale leveling indicator.



Take the battery out when scale is not in use for long time. Leakage from the batteries is hazardous.

## PREFACE

Thank you for purchasing CAS PRII series.

These series have been designed with CAS reliability, under rigid quality control and with outstanding performance. Your special departments can enjoy these high quality reliable CAS products.

We believe that your needs will be satisfied and you will have proper reliability.

This manual will help you with proper operation and care of the PRII.

Please keep it handy for future reference.

## OVERALL VIEW

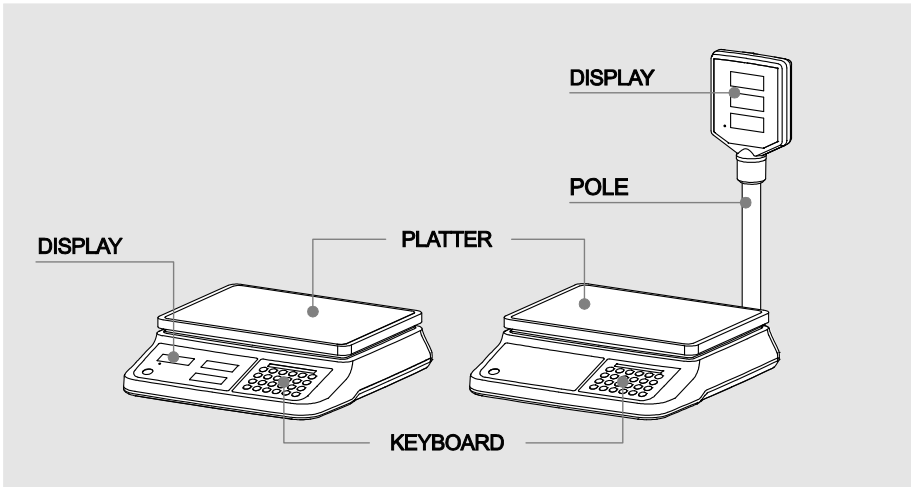

## DISPLAY & KEY BOARD

### PR II - B Front display

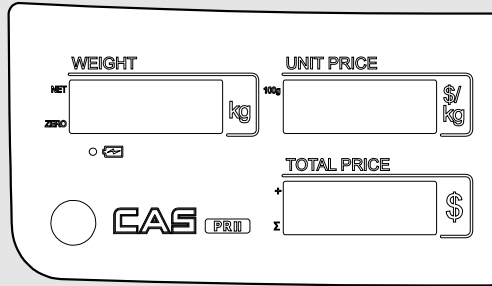



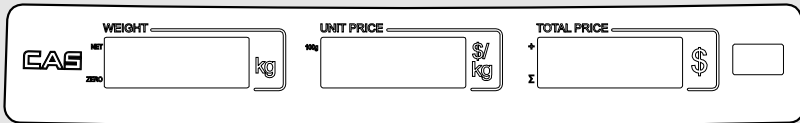



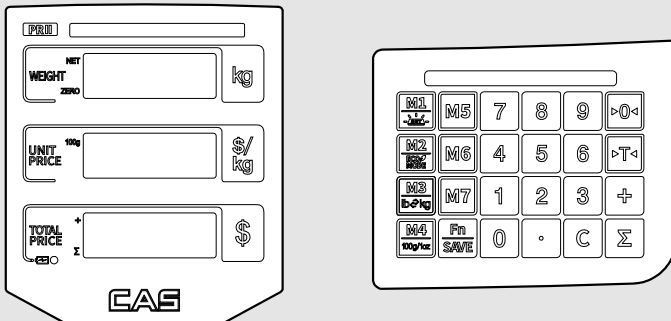



### PR II - B Rear display



### PR II - P Front cover & key

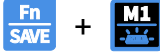
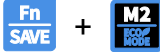
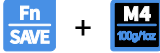

# KEY FUNCTIONS

KEYS	FUNCTIONS
 ~ 	Used to enter all the numeric data
 ~ 	PLU key.
	Function key(Back-light, Power Save Used to enter PLU setting
	Used to clear all the numeric price display Used to clear sum total price Used to clear all the daily total prices
	Used to correct the zero point
	To set or clear tare value
	PLU save key. To make several sales transaction by adding up.
	To check total sales amount or finalize sales transaction.
	Used to enter the decimal point when price is entered.
	Used to change back-light setting.(OFF, ON, AUTO)
	Power Save Mode
	Used to price per 100g (\$/100g)

# COLUMN INSTALLATION

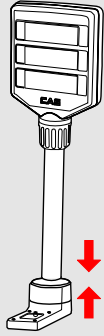

**Figure one**

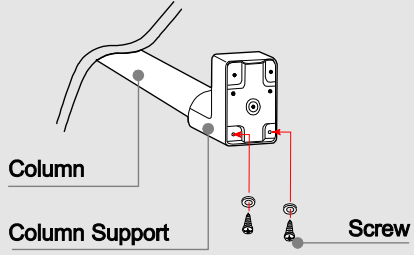

**Figure two**



## OPERATIONS

- Turn on the ON/OFF switch. Then, the display will show all the segments and count up "9" to "0".

### Chapter 1. Basic Operation

#### a. Zero function

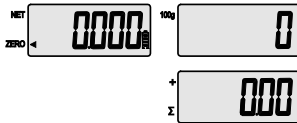

- ① Press ZERO key to set Zero.

#### b. Tare function

Tare means the weight of container. You may use tare function when you weigh an item with container and measure only the weight of item.

- One time tare

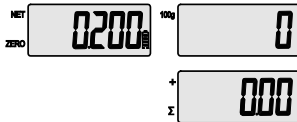
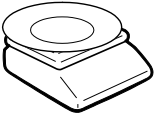

- ① Place a container on the platter.

EX) 200g of tare.

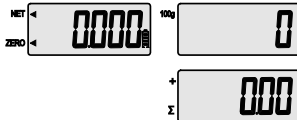

- ② Press TARE key to set zero point.

EX) 200g of tare.

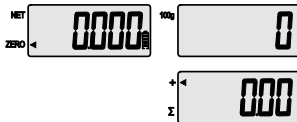

● Successive tare

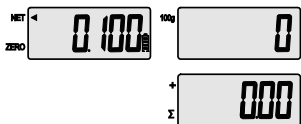
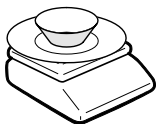

③ Place another container on the platter.

EX) 100g of tare.

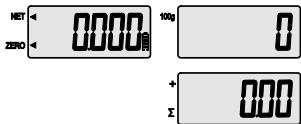

④ Press TARE key to set zero point.

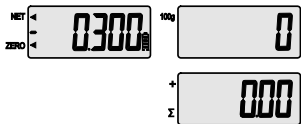

⑤ After weighing item remove all of the container from the platter.

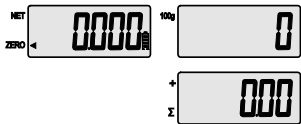

⑥ Press TARE key again to set zero.

● NOTICE : To remove TARE function press "TARE" Key again after removing the container from the platter. Automatic tare clearing function may not be applied to all of PR series.

## Chapter 2. PLU Saving & Calling-up

### a. Saving unit price on PLU

This section explains how to save unit price in PLU.

	Number of PLU	Range	Remarks
PLU NAME	7	1~7	

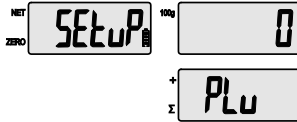

① Press the 'Fn' key for a few seconds then, Set-up menu will be shown.

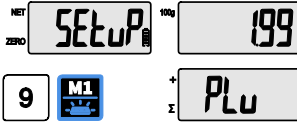

② After input unit of price, press number of PLU that you want to set up.



### b. Calling up PLU

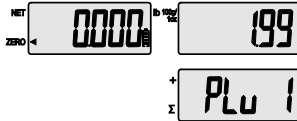



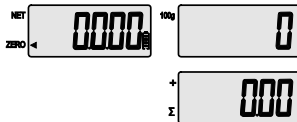





① Press M1 ~ M7 key to call up PLU. e.g, Press M1 key.



② Press C key to clear and return to the normal weighing mode.

### Chapter 3. User's Set-up Mode

This section explains how to set up the following functions.

KEY	Display	FUCTION	Remarks
 + 	bL-At	Use back-light when you put on the weight	
	bL-oFF	Do not use a back-light.	
	bL-on	Use back-light always	
 + 	ps - 0	Do not use power save mode.	
	ps - 1	Use power save mode	
 + 	up- kg	Used to price per kg	
	up-100g	Used to price per 100g (\$/100g).	
 + 	rS-Co	Continually mode	
	rS-PC	Command mode	
	rS-St	Stable mode	

# Chapter 4. Sales transaction

PR-II can provide inputting the unit price through the numeric key and calling up PLU.

## a. Input the unit price through the numeric key

This section explains how to input the unit price through the numeric key and complete the sales transaction.

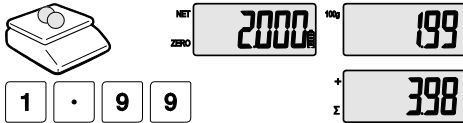

① Place an item on the platter and press appropriate numeric keys to input unit price.

EX) 1.99 for unit price.



② Remove the item from the platter.

## b. Input the unit price through calling up PLU



① Press M1~M7 key can call up the PLU. EX) M1



② Place an item on the platter.



③ Remove an item on the platter.

## c. Adding up several sales transactions for weighed items

- Use + key to makes the adding-up transactions.
- You may either call up PLU or just input the unit price.

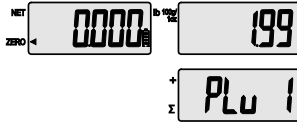

① Press M1~M7 key can call up the PLU. EX) M1

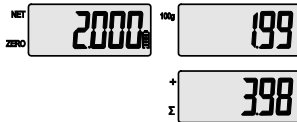
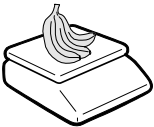

② Place an item on the platter.

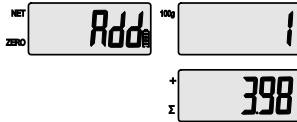

③ Press + key.

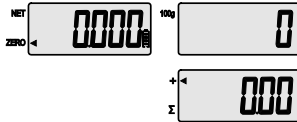

④ Remove the item from the platter.



⑤ Input a unit price.

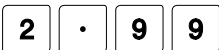

EX) 2.99 for Honey melon

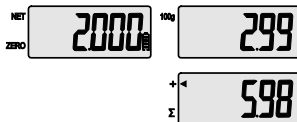
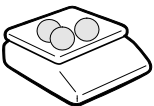

⑥ Place an item on the platter.

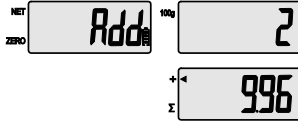

⑦ Press + key. "Total Price" display says total price added, and "Unit Price" display says the number of sales transactions added.

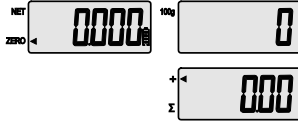
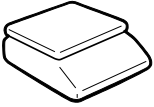

⑧ Remove the item from the platter.

- You may also place the item on the platter first and then input unit price in the scale later.

# Chapter 5. Payment

## a. Payment function on total sales amount

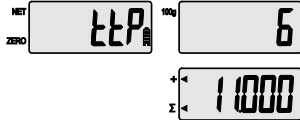

① Press  $\Sigma$  key to call up total price.  
(If you want to go back to sales mode, press zero key.)

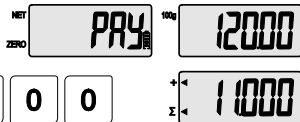

② Input payment of consumer by numeric key.



Ex) 120.00 payment

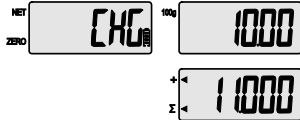

③ Press  $\Sigma$  key to call up the change amount.

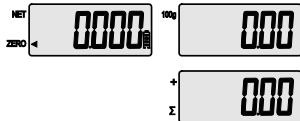

④ After checking the change amount press  $\Sigma$  key to go back to normal weighing mode.



## b. Deleting total sales data

**Σ**

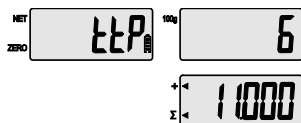

① Press  $\Sigma$  key to call up total price.  
(If you want to go back to sales mode,  
press zero key.)

**C**

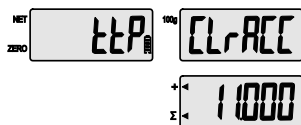

② Press C key to delete "total sales" data.  
Clear account message shows up shortly,  
and then it goes to normal weighing mode.

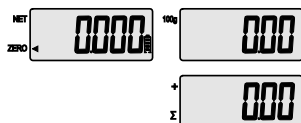

③ And then it goes to normal weighing mode.

# Chapter 6. Interface in Detail

This function is helpful to understand RS-232C Communication user setting.  
The following is the communication information of RS-232C.

## ● RS-232C Port Connection

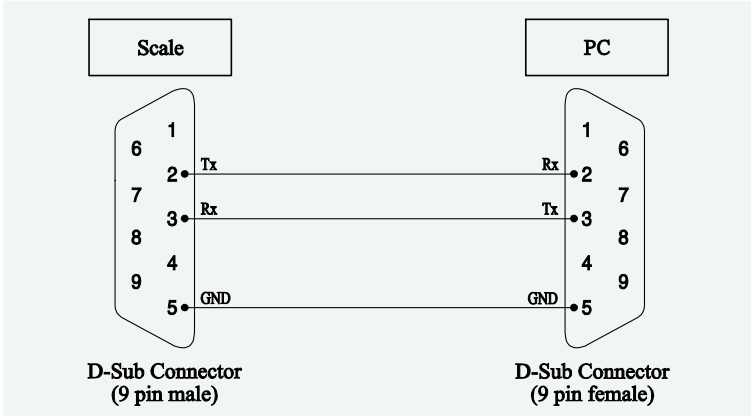

- ➔ 8-BIT ASCII code
- ➔ None parity
- ➔ 1 stop bit
- ➔ baud rate 9600

## ● USB INTERFACE(Device)

USB Type B Socket

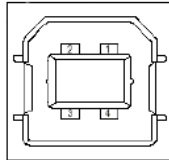

- 1=Vbus (5V)
- 2=D-
- 3=D+
- 4=GND

● RS-232C Protocol

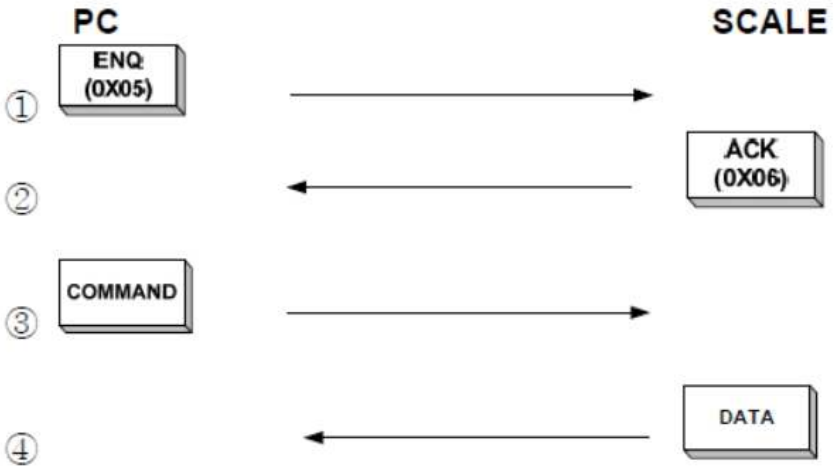

**Transmission Data description**

DATA	Value(HEX)	Description
SOH	01h	Start of heading
STX	02h	Start of text
STA	S(53h),U(55h)	S: Stable , U:Unstable
SIGN	-(2Dh),SP(20h)	Sign of the weight data
W5~W0		Weight data
UN1,UN2	KG,LB	Unit of Weight
BCC		Block check character exclusive or(^)
ETX	03h	End of text
EOT	04h	End of transmission

**COMMAND : DC2(0X12) SCALE -> PC DATA FORMAT**

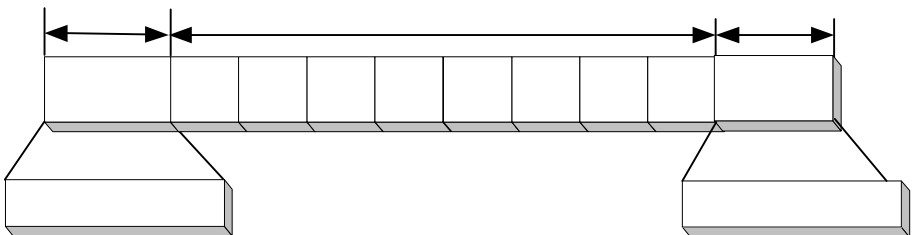
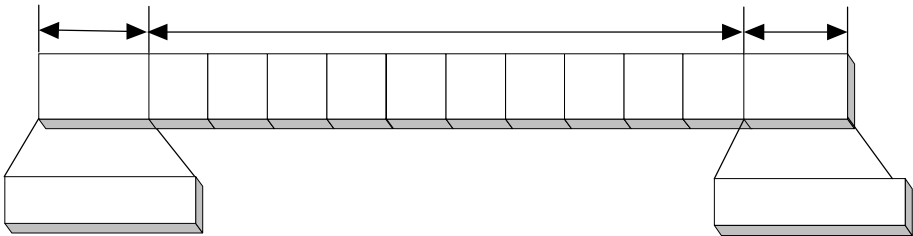
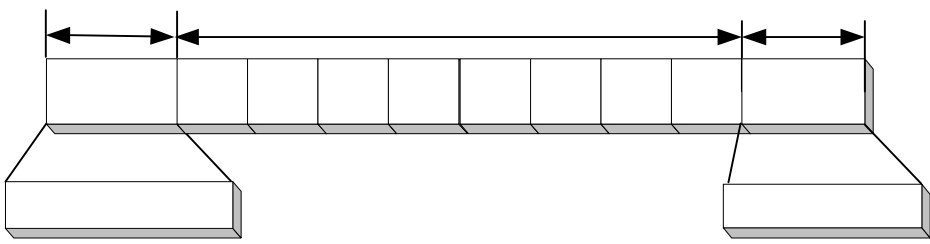

**All Data Format (total price,weight,unit price)**

## MAINTENANCE



### LOW BATTERY WARNING

This product is a combination product dry battery and rechargeable battery. When the battery is low the display shows the " bAt-Lo " sign. You can replace the battery new one.

If rechargeable battery, please charge immediately. You can shorten battery life.

If you still use the scale without replacing the battery the scale may provide incorrect result on measurement.

## ERROR MESSAGE

Error Message on Display	Description	Solution
	The "Z-Err" occurs when a current zero point has shifted from the last span calibration.	Please call your CAS dealer.
	The "oL" is an overload error.	Please remove the weight.
	The "bAt-Lo" is battery low.	Please change new battery. If rechargeable battery, please charge immediately.

# SPECIFICATIONS

## MODEL : PRII

Capacity	Dual Interval	Single	Dual Interval	Single	Dual Interval	Single
	Max 3/6kg	Max 6kg	Max 6/15kg	Max 15kg	Max 15/30kg	Max 30kg
e	e=1/2g	e=2g e=1g e=0.5g e=0.2g	e=2/5g	e=5g e=2g e=1g e=0.5g	e=0.5/1g	e=10g e=5g e=2g e=1g
<b>External Resolution</b>	1/3000	1/3000~ 1/30000	1/3000	1/3000~ 1/30000	1/3000	1/3000~ 1/30000
<b>MAX Tare</b>	-1.4995 kg	-2.999 kg	-5.998 kg	-14.995 kg	-14.995 kg	-29.990 kg
<b>Display</b>	6/6/6(Weight / Unit price/ Total price)					
<b>Symbols</b>	ZERO, TARE, kg/lb,100g/1oz, ADD, SUM, Low Battery, AC POWER					
<b>Keys</b>	ZERO, TARE, M1~M7 KEY, FUCTION, ADD, SUM					
<b>Functions</b>	Direct PLU 7 Unit Conversion Power Save Mode Back-light ON/OFF Control Function					
<b>Dimensions</b>	P TYPE : 341 (W) x 435 (D) x 474 (H)[mm] / 134 (W) x 171 (D) x 186 (H)[inch] B TYPE : 341 (W) x 383 (D) x 102 (H)[mm] / 134 (W) x 151 (D) x 40 (H)[inch] U TYPE : 341 (W) x 435 (D) x 474 (H)[mm] / 134 (W) x 171 (D) x 186 (H)[inch]					
<b>Platter size</b>	330 (W) x 235 (D)[mm] / 129.92 (W) x 92.52 (D)[inch]					
<b>Weight</b>	2.8 kg					
<b>Power</b>	1.5 V x 3 units (D size Battery), Pb 4V/4Ah, 6 V Adapter					
<b>Operation Time</b>	Approx. 300 hours (Manganese Battery) / 600 hours (Alkaline at 20 °C / 68 °F) / <b>Backlight off</b>					
<b>Operating Temperature</b>	-10 °C ~ +40 °C / 14 °F ~ 104 °F					
<b>Option</b>	RS232, USB, Manganese Battery, Pole Type					

※ Notice: Specifications are subject to change for improvement without notice.









# RETAIL WEIGHING SOLUTION™



CAS BLDG., #1315, YANGJAE-DAERO,  
GANGDONG-GU, SEOUL, KOREA

TEL\_ 82 2 2225 3500  
FAX\_ 82 2 475 4668  
[www.globalcas.com](http://www.globalcas.com)



9002-PRE-0033-0 2016.03

---